

Article number: 20343660M16125KR

Description: E+G levelling foot
GN 343.6-60-M16-125-KR

Measures

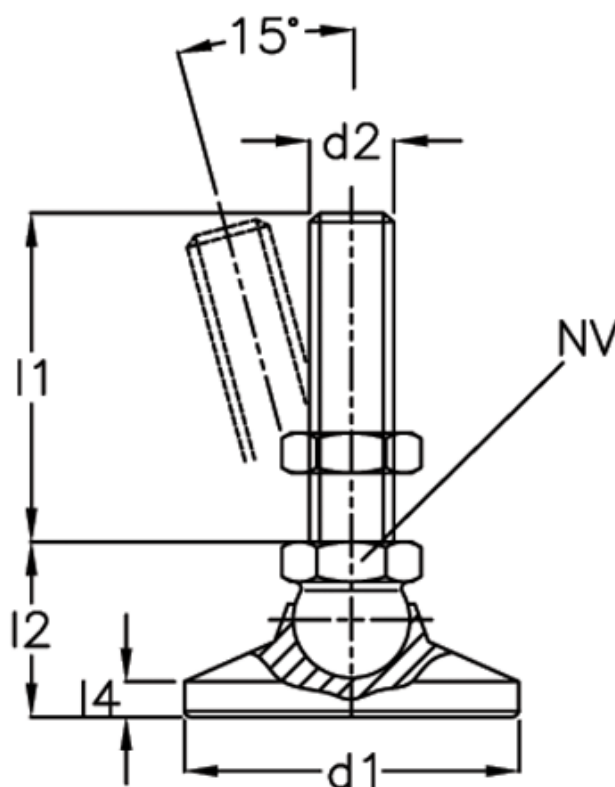

A/F	= 24
d1	= 60
d2	= 16
l1	= 125
l2	= -
l4	= -
Static load (N)	= 30
Weight in (g)	= 524